

RFC-XL

User Manual



Table of Contents

1. Before You Begin	1
What Is Included	1
Unpacking Instructions.....	1
Claims	1
Text Conventions	1
Symbols	1
Disclaimer	1
Intellectual Property	1
Safety Notes.....	2
2. Introduction	3
Product Overview.....	3
Product Dimensions.....	3
3. Setup	4
RFC- XL Remote Control.....	4
Radio Frequency Public Linking.....	4
Battery Power.....	4
4. Operation	5
RFC- XL Remote Operation.....	5
5. Technical Specifications	8
Contact Us	9
Warranty & Returns.....	9

1. Before You Begin

What Is Included

- RFC- XL
- Alkaline battery (A23)
- Quick Reference Guide

Unpacking Instructions

Carefully unpack the product immediately and check the container to make sure all the parts are in the package and are in good condition.

Claims





If the box or the contents (the product and included accessories) appear damaged from shipping, or show signs of mishandling, notify the carrier immediately, not Chauvet. Failure to report damage to the carrier immediately may invalidate your claim. In addition, keep the box and contents for inspection.

For other issues, such as missing components or parts, damage not related to shipping, or concealed damage, file a claim with Chauvet within 7 days of delivery.

Text Conventions

Convention	Meaning
1–512	A range of values
50/60	A set of values of which only one can be chosen
Settings	A menu option not to be modified
<ENTER>	A key to be pressed on the product's control panel
ON	A value to be entered or selected

Symbols

Symbol	Meaning
	Electrical warning. Not following these instructions may cause electrical damage to the product, accessories, or the user.
	Critical installation, configuration, or operation information. Not following these instructions may make the product not work, cause damage to the product, or cause harm to the operator.
	Important installation or configuration information. The product may not function correctly if this information is not used.
	Useful information.

Disclaimer

Chauvet believes that the information contained in this manual is accurate in all respects. However, Chauvet assumes no responsibility and specifically disclaims any and all liability to any party for any loss, damage or disruption caused by any errors or omissions in this document, whether such errors or omissions result from negligence, accident or any other cause. Chauvet reserves the right to revise the content of this document without any obligation to notify any person or company of such revision, however, Chauvet has no obligation to make, and does not commit to make, any such revisions. Download the latest version from www.chauvetdj.com.

Intellectual Property

The works of authorship contained in this manual, including, but not limited to, all design, text and images are owned by Chauvet.

© Copyright 2023 Chauvet & Sons, LLC. All rights reserved.

Electronically published by Chauvet in the United States of America.

CHAUVET, the Chauvet logo, and RFC- XL are registered trademarks or trademarks of Chauvet & Sons LLC. (d/b/a Chauvet and Chauvet Lighting) in the United States and other countries. Other company and product names and logos referred to herein may be trademarks of their respective companies.

Safety Notes



■ **ALWAYS:**

- ◆ In the event of a serious operating problem, stop using immediately.

■ **DO NOT:**

- ◆ Open this product or attempt any repairs. It contains no user-serviceable parts.
- ◆ Operate in temperatures higher than 104°F (40°C).
- ◆ Expose to environments that exceed the Ingress Protection (IP) rating.
- ◆ Expose to rain or moisture.
- ◆ Use outdoors.
- ◆ Submerge.
- ◆ Leave outdoors for extended periods of time.
- ◆ Expose to corrosive environmental conditions such as temperature, humidity, salinity, pressure, radiation, or shock.
- ◆ Set this product on a flammable surface.



Keep this User Manual for future use. If the product is sold to someone else, be sure that they also receive this document.

2. Introduction

Product Overview

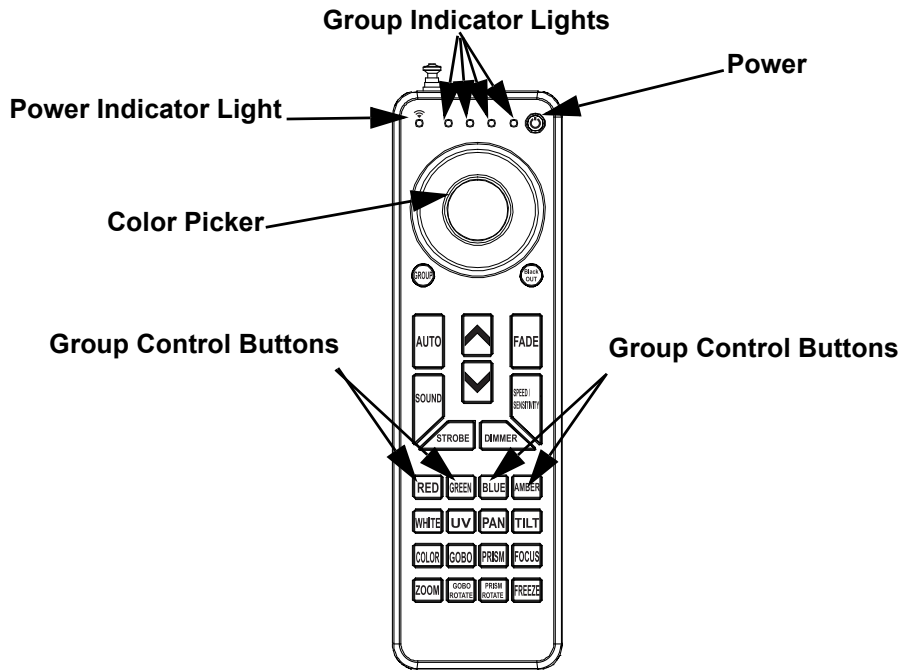

Product Dimensions

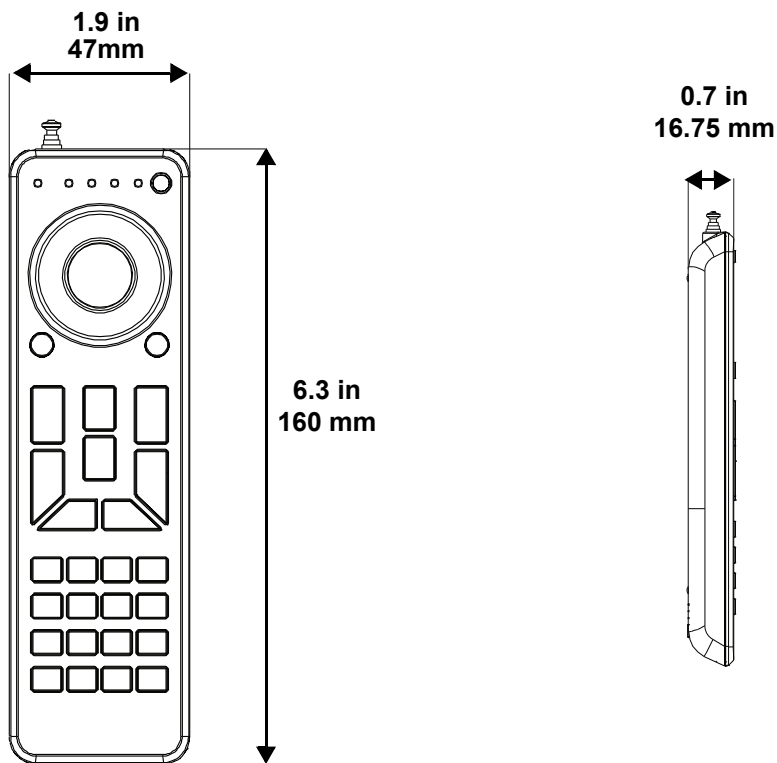

3. Setup

RFC- XL Remote Control

The RFC- XL can be operated with any Chauvet RF enabled fixture. RF wireless control must be set on the fixture. To enable RF wireless control in the fixture, locate the RF function in the Menu Map and enable RF.

Binding

To bind the fixture to the remote, navigate to the <BIND> option in the fixture's Menu Map and follow instructions.

NOTE: Once the remote has binded to the fixture, it is possible to select a group on the fixture. Assigning the fixture to a group will be important when using the remote, as the remote can command multiple groups at once.

Radio Frequency Public Linking

The RFC- XL can also operate with fixtures that are not binded by using the RF public linking option. Locate the RF function in the menu map and select the public linking option.

NOTE: Public operation allows the fixture to respond to all RF signals and undesired results may present themselves.

Battery Power

The RFC- XL is battery operated. Ensure that the Alkaline battery (A23) is installed prior to operating the remote.







- **Movement may cause the back lights to turn on and drain the battery will being transported. Turn off the unit when not in use.**

4. Operation

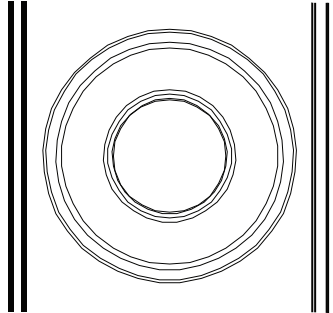
RFC- XL Remote Operation

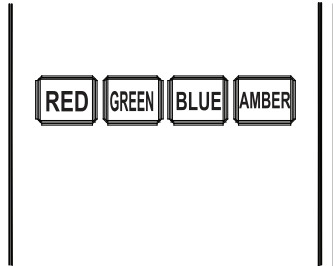
The RF remote functions will vary from fixture to fixture. Some RF functions on the remote may not be applicable.

Remote	Function
	<p>COLOR PICKER</p> <p>The color picker can be used to select colors manually instead of cycling through preset colors. In addition, the color picker can increase or decrease the value of several functions in the fixture such as the dimmer, pan, or tilt.</p> <p>To manually select a color or adjust the value of a function:</p> <ol style="list-style-type: none"> 1. Select function such as <PAN>, <DIMMER>, <COLOR>, <STROBE> or <FOCUS>. 2. Press any part of the color picker and scroll clockwise or counterclockwise.
 	<p>GROUP</p> <p>To select a group on the remote:</p> <ol style="list-style-type: none"> 1. Press <GROUP> 2. Press the appropriate group control buttons to select the corresponding group. For example: <ul style="list-style-type: none"> • Press <RED> to select group 1. • Press <GREEN> to select group 2. • Press <BLUE> to select group 3. • Press <AMBER> to select group 4. 3. Once the groups are selected, press any of the applicable functions on the remote to control the selected fixtures. <p>NOTE: When a group is selected, the group indicator light will remain on. Several groups may be selected at once. If several groups have been selected, several indicator lights will remain on until the groups are turned off.</p>
	<p>BLACK OUT</p> <p>Turns off everything on the fixture, or selected fixture group.</p> <ol style="list-style-type: none"> 1. Press <BLACK OUT>. <p>To turn off this function, press <BLACK OUT> again.</p>

Remote	Function
	<p>AUTO Triggers built in programs in the fixture.</p> <ol style="list-style-type: none"> 1. Press <AUTO>. 2. Press <UP> or <DOWN> to choose between the different auto programs. 3. Press <SPEED/SENSITIVITY>. 4. Press <UP> or <DOWN> or use the color picker to increase or decrease the program speed
	<p>FADE Toggles some auto programs to snap or fade.</p> <ol style="list-style-type: none"> 1. Use a function involving the transition of colors (i.e while auto is playing). 2. Press <FADE>. 3. Press <SPEED/SENSITIVITY>. 4. Press <UP> or <DOWN> or use the color picker to increase or decrease the auto program speed.
	<p>SOUND Triggers built in sound programs.</p> <ol style="list-style-type: none"> 1. Press <SOUND>. 2. Press <SPEED/SENSITIVITY>. 3. Press <UP> or <DOWN> or use the color picker to increase or decrease the sensitivity.
	<p>STROBE Triggers strobe mode in the fixture.</p> <ol style="list-style-type: none"> 1. Press <STROBE>. 2. Press <UP> or <DOWN> or use the color picker to adjust the strobe.
	<p>DIMMER Triggers dimmer mode in the fixture.</p> <ol style="list-style-type: none"> 1. Press <DIMMER>. 2. Press <UP> or <DOWN> or use the color picker to adjust the brightness.

Remote	Function
	<p>PAN Rotates the fixture left or right.</p> <ol style="list-style-type: none"> 1. Press <PAN>. 2. Press <UP> or <DOWN> or use the color picker to adjust the pan.
	<p>TILT Moves the fixture up and down.</p> <ol style="list-style-type: none"> 1. Press <TILT>. 2. Press <UP> or <DOWN> or use the color picker to adjust the tilt.
	<p>COLOR The color function cycles through the fixture's preset colors.</p> <ol style="list-style-type: none"> 1. Press <COLOR>. 2. Press <COLOR> again or use the color picker to adjust colors. <p>Note: Does not apply to all fixtures.</p>
	<p>GOBO Cycles through available gobos.</p> <ol style="list-style-type: none"> 1. Press <GOBO>. 2. Press <GOBO> again to adjust gobos.
	<p>PRISM</p> <ol style="list-style-type: none"> 1. Press <PRISM>. 2. Press <UP> or <DOWN> or use the color picker to adjust the prism. 3. Press <UP> or <DOWN> or use the color picker to adjust the prism rotate.
	<p>FOCUS Adjusts the focus.</p> <ol style="list-style-type: none"> 1. Press <FOCUS>. 2. Press <UP> or <DOWN> or use the color picker to increase or decrease the focus.
	<p>ZOOM Zooms in and out.</p> <ol style="list-style-type: none"> 1. Press <ZOOM>. 2. Press <UP> or <DOWN> or use the color picker to adjust the zoom function.
	<p>GOBO ROTATE The gobo rotate function rotates the gobo either clockwise or counterclockwise.</p> <ol style="list-style-type: none"> 1. Press <GOBO ROTATE>. 2. Press <UP> or <DOWN> to or use the color picker to cycle through gobos.
	<p>PRISM ROTATE</p> <ol style="list-style-type: none"> 1. Reserved for future use.
	<p>FREEZE Stops all movement and color chasing in all fixtures.</p> <ol style="list-style-type: none"> 1. Press <FREEZE>. <p>NOTE: The RF remote will not respond to any inputs when Freeze is activated. If the product does not respond when a button is pressed, try pressing <FREEZE>. Freeze may have been activated.</p>

5. Technical Specifications

Dimensions and Weight

Length	Width	Height	Weight
6.3 in (160 mm)	1.9 in (47 mm)	0.7 in (17 mm)	12.6 oz (357 g)

Note: Dimensions in inches rounded to the nearest hundredth.

Battery

Type	Capacity	Voltage	Power
Alkaline (A23)	55 mAh	12 VDC	0.66 Wh

Ordering

Product Name	Item Code	UPC Number
RFC- XL	10082009	781462223571



Contact Us

General Information	Technical Support
Chauvet World Headquarters	
Address: 3360 Davie Rd. Davie, FL 33314 Voice: (954) 577-4455 Fax: (954) 929-5560 Toll Free: (800) 762-1084	Voice: (844) 393-7575 Fax: (954) 756-8015 Email: chauvetcs@chauvetlighting.com Website: www.chauvetprofessional.com
Chauvet U.K.	
Address: Unit 1C Brookhill Road Industrial Estate Pinxton, Nottingham, UK NG16 6NT Voice: +44 (0) 1773 511115 Fax: +44 (0) 1773 511110	Email: UKtech@chauvetlighting.eu Website: www.chauvetprofessional.eu
Chauvet Benelux	
Address: Stokstraat 18 9770 Kruishoutem Belgium Voice: +32 9 388 93 97	Email: BNLtech@chauvetlighting.eu Website: www.chauvetprofessional.eu
Chauvet France	
Address: 3, Rue Ampère 91380 Chilly-Mazarin France Voice: +33 1 78 85 33 59	Email: FRtech@chauvetlighting.fr Website: www.chauvetprofessional.eu
Chauvet Germany	
Address: Bruno-Bürgerl-Str. 11 28759 Bremen Germany Voice: +49 421 62 60 20	Email: DEtech@chauvetlighting.de Website: www.chauvetprofessional.eu
Chauvet Mexico	
Address: Av. de las Partidas 34 - 3B (Entrance by Calle 2) Zona Industrial Lerma Lerma, Edo. de México, CP 52000 Voice: +52 (728) 690-2010	Email: servicio@chauvet.com.mx Website: www.chauvetprofessional.mx

Warranty & Returns

For warranty registration and complete terms and conditions, please visit the Chauvet website.

For customers in the United States and Mexico: www.chauvetlighting.com/warranty-registration.

For customers in the United Kingdom, Republic of Ireland, Belgium, the Netherlands, Luxembourg, France, and Germany: www.chauvetlighting.eu/warranty-registration.